

KIDBRIGHT32

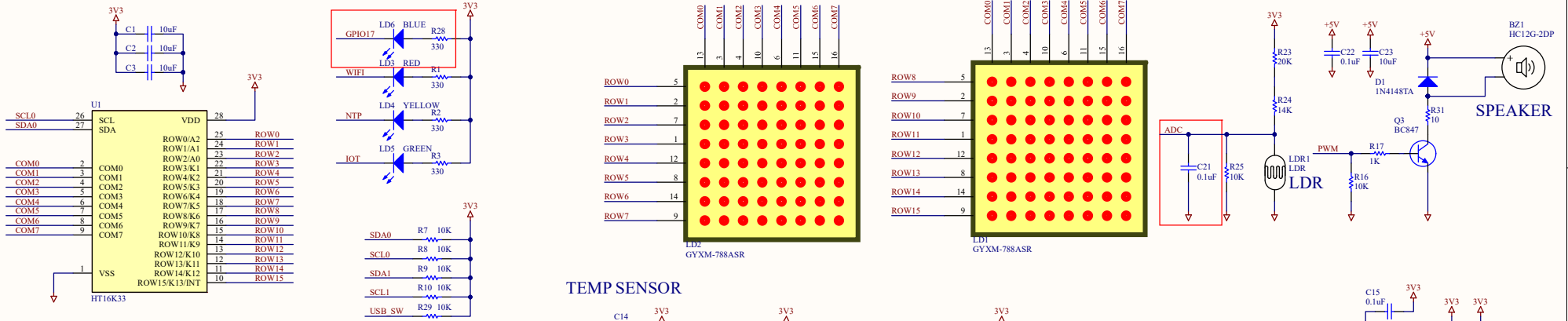

KidBright Chain

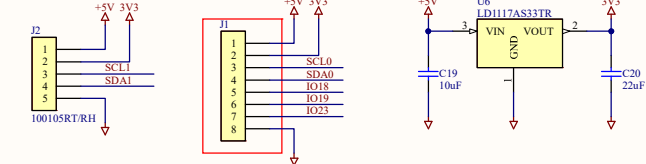

TEMP SENSOR

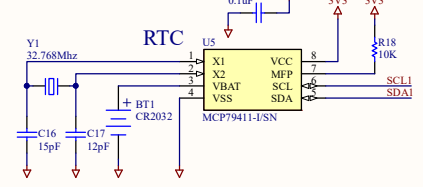
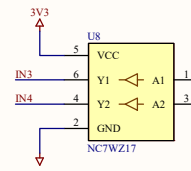
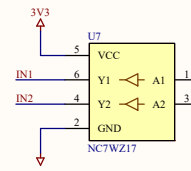
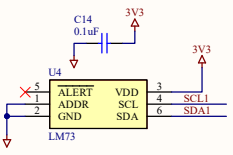

SWITCH1

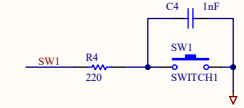

SWITCH2

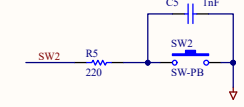

RESET SWITCH

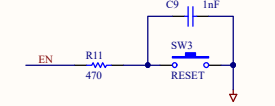

USB UART BRIDGE (PROGRAM)

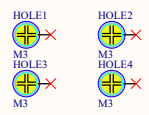
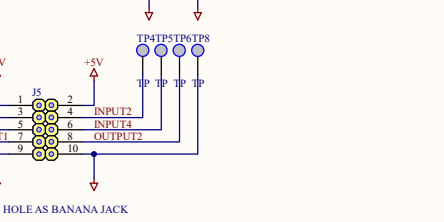
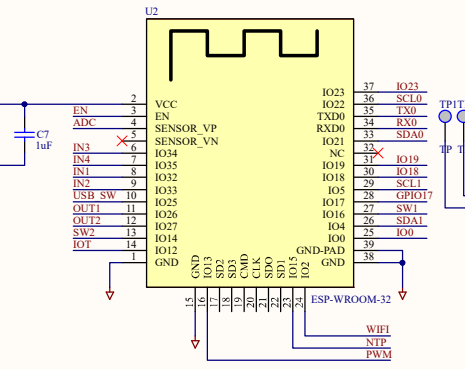
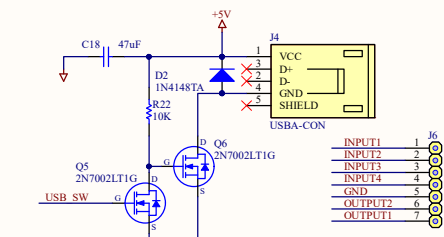
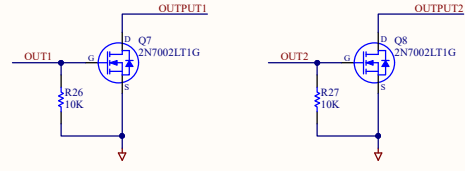
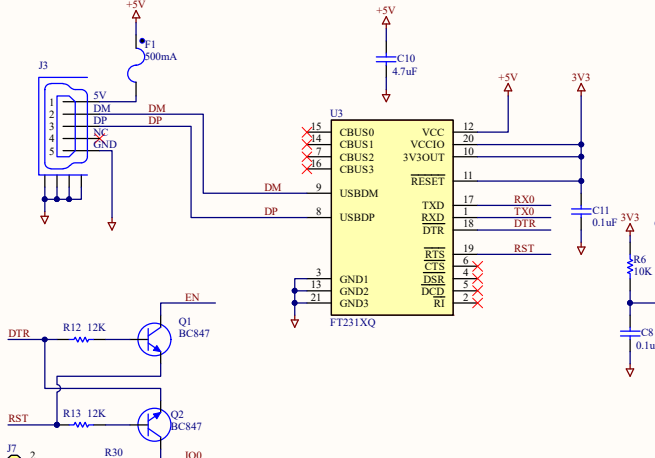

TITLE	SCH-KIDBRIGHT32	NAME		DATE	22/10/2018	DRAWING NO:		SHEET	1 OF 1
DESCRIPTION		DRAWN:	vichien	PART NO:		FILE NAME:		REV:	V 1.3
		CHECKED:		UNITS:		SCALE:		SIZE:	
		APPROVED:							